

GREEN 2

GREEN 4

USER MANUAL
BEDIENUNGSANLEITUNGEN
MANUALE DI ISTRUZIONI
MODE D'EMPLOI
MANUAL DEL USUARIO
GEBRUIKERSHANDLEIDING
MANUAL DO UTILIZADOR
작동 설명서

Before connecting the battery charger to the mains and to the battery, **READ THE FOLLOWING INSTRUCTIONS CAREFULLY.**

Vor dem Anschließen des Batterieladegeräts an das Stromnetz und an die Batterie **UNBEDINGT AUFMERKSAM NACHSTEHENDE ANLEITUNGEN LESEN.**

Prima di connettere il caricabatterie alla rete ed alla batteria, **VI PREGHIAMO DI LEGGERE ATTENTAMENTE LE SEGUENTI ISTRUZIONI.**

Avant de connecter le chargeur de batterie au secteur et à la batterie, **NOUS VOUS PRIONS DE LIRE ATTENTIVEMENT LES INSTRUCTIONS SUIVANTES.**

Antes de conectar el cargador a la red eléctrica y a la batería, **LEER CUIDADOSAMENTE LAS SIGUIENTES INSTRUCCIONES.**

Alvorens de acculader aan te sluiten op het elektriciteitsnet en op de accu, **DEZE AANWIJZINGEN AANDACHTIG LEZEN.**

Antes de ligar o carregador de bateria na tensão de alimentação e na bateria, **LER COM ATENÇÃO AS SEGUINTE INSTRUÇÕES.**

배터리 충전기를 전원 공급장치와 배터리에 연결하기 전에 아래의 지침을 자세히 읽어 주십시오

WARNING! This is an **EMC complying product** in class A+B as defined by the CEI EN 61000-6-2, CEI EN 61000-6-3 and CEI EN 61000-6-4 regulations, in other words both for use in **RESIDENTIAL ENVIRONMENTS** and in **INDUSTRIAL ENVIRONMENTS**

ACHTUNG! Vorliegendes Produkt entspricht der **EMV-Richtlinie** Klasse A+B, so wie von den Normen CEI EN 61000-6-2, CEI EN 61000-6-3 und CEI EN 61000-6-4 vorgesehen, d. h. es ist sowohl für den Gebrauch in **WOHN- ALS AUCH INDUSTRIEBEREICHEN** geeignet.

ATTENZIONE! Il presente è un **prodotto conforme alla Direttiva EMC** nella classe A+B così come previsto dalle norme CEI EN 61000-6-2, CEI EN 61000-6-3 e CEI EN 61000-6-4, in altri termini per utilizzo in **AMBIENTI** sia **RESIDENZIALI** sia **INDUSTRIALI**

ATTENTION! Ce produit est **conforme à la Directive CEM** dans la classe A+B tel que prévu par les normes CEI EN 61000-6-2, CEI EN 61000-6-3 et CEI EN 61000-6-4, c'est-à-dire à utiliser dans des **ENVIRONNEMENTS** tant **RÉSIDENTIELS** qu'**INDUSTRIELS**.

ATENCIÓN! Este es un **producto que cumple** con la **CEM** en clase A+B como se define en las Normativas ICE EN 61000-6-2, ICE EN 61000-6-3 y ICE EN 61000-6-4, es decir, para uso tanto en **AMBIENTES RESIDENCIALES** como **INDUSTRIALES**.

WAARSCHUWING! Dit is een product dat in **overeenstemming is met de EMC-richtlijn** in klasse A+B zoals gedefinieerd in de voorschriften CEI EN 61000-6-2, CEI EN 61000-6-3 en CEI EN 61000-6-4, met andere woorden, zowel voor **HUISHOUDELIJKE** als **INDUSTRIËLE OMGEVINGEN**.

ATENÇÃO! Este é um **produto em conformidade com a directiva EMC** na la classe A + B como definido pelas normas CEI EN 61000-6-2, CEI 61000-6-3 e CEI EN 61000-6-4, que é para **AMBIENTES RESIDENCIAIS** e **INDUSTRIAIS**.

조심해! 이 제품은 환경에서 사용하는 즉, **CEI EN 61000-6-2, IEC 61000-6-3 및 IEC 61000-6-4** 에서 요구하는 클래스 **A + B** 를에 **EMC** 지침을 준수입니다 주거 산업이다



BATTERY CHARGER IDENTIFICATION LABEL
TYPENSCHILD DES BATTERIE-LADEGERÄTES
ETICHETTA IDENTIFICATIVA DEL CARICABATTERIA
ÉTIQUETTE D'IDENTIFICATION DU CHARGEUR DE BATTERIE
ETIQUETA DE IDENTIFICACIÓN DEL CARGADOR DE BATERÍA
IDENTIFICATIELABEL ACCULADER
ETIQUETA DE IDENTIFICAÇÃO DO CARREGADOR DE BATERIA
배터리 충전기 식별 라벨

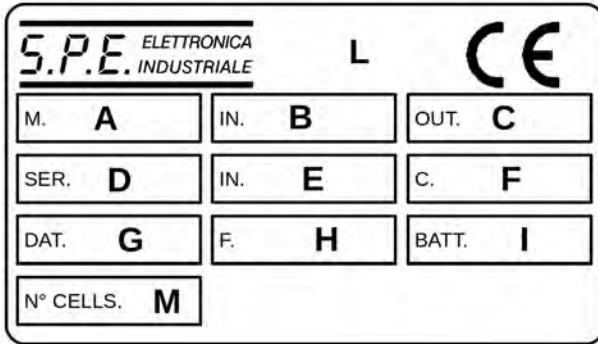

| A | MODEL | MODELL | MODELLO | MODÈLE | MODELO | MODEL | MODELO | 모델 |
|---|----------------------------------|--|---------------------------------------|---|-----------------------------------|-----------------------------|---|---------------|
| B | INPUT VOLTAGE | VERSORGUNGSSPANNUNG | TENSIONE DI ALIMENTAZIONE | TENSION D'ALIMENTATION | TENSIÓN DE ALIMENTACIÓN | INGANGS-SPANNING | TENSÃO DE ALIMENTAÇÃO | 입력 전압 |
| C | OUTPUT VOLTAGE AND CURRENT | AUSGANGS-SPANNUNG UND STROM | TENSIONE E CORRENTE DI USCITA | TENSION ET COURANT DE SORTIE | TENSIÓN Y CORRIENTE DE SALIDA | UITGANGS-SPANNING EN STROOM | TENSÃO E CORRENTE NA SAÍDA | 출력 전압 및 전류 |
| D | BATTERY CHARGER SERIAL NUMBER | SERIENNUMMER DES BATTERIE-LADEGERÄTES | NUMERO DI SERIE DEL CARICABATTERIA | NUMÉRO DE SÉRIE DU CHARGEUR DE BATTERIE | NÚMERO DE SERIE DEL CARGADOR | SERIE-NUMMER ACCULADER | NÚMERO DE SÉRIE DO CARREGADOR DE BATERIA | 배터리 충전기 일련 번호 |
| E | MAINS ABSORPTION | NETZ-STROMAUFNAHME | ASSORBIMENTO DI RETE | ABSORPTION DE RÉSEAU | ABSORCIÓN DE RED | ABSORPTIE NET-SPANNING | ABSORÇÃO DA ALIMENTAÇÃO | 메인 전원 흡수 |
| F | CHARGING CURVE | LADEKURVE | CURVA DI CARICA | COURBE DE CHARGE | CURVA DE CARGA | LAADCURVE | CURVA DE CARGA | 충전 곡선 |
| G | BATTERY CHARGER MANUFACTURE DATE | HERSTELLDATUM DES BATTERIE-LADEGERÄTES | DATA FABBRICAZIONE DEL CARICABATTERIA | DATE DE FABRICATION DU CHARGEUR DE BATTERIE | FECHA DE FABRICACIÓN DEL CARGADOR | FABRICAGE-DATUM ACCULADER | DATA DE FABRICAÇÃO DO CARREGADOR DE BATERIA | 배터리 충전기 제조일 |
| H | MAINS FUSE VALUE | WERT NETZ-SICHERUNG | VALORE FUSIBILE DI RETE | VALEUR FUSIBLE DE RÉSEAU | VALOR FUSIBLE DE RED | ZEKERING-WAARDE NETSPANNING | VALOR DO FUSÍVEL DA ALIMENTAÇÃO | 메인 퓨즈 값 |

| | | | | | | | | |
|--|------------------------------|-------------------------------------|--|--|--------------------------------------|-----------------------------------|------------------------------------|-----------|
| I | BATTERY CAPACITY RANGE | BEREICH BATTERIELEISTUNG | GAMMA CAPACITA' BATTERIE | GAMME CAPACITÉ DES BATTERIES | GAMA DE CAPACIDAD BATERIAS | CAPACITEIT S-BEREIK ACCU | INTERVALO DE CAPACIDADE DA BATERIA | 배터리 용량 범위 |
| L | PRODUCT CERTIFICATION STAMPS | KENNZEICHNUNG PRODUKTZERTIFIZIERUNG | MARCHI CERTIFICAZIONE DI PRODOTTO | MARQUES DE CERTIFICATION DE PRODUIT | MARCAS DE CERTIFICACION DEL PRODUCTO | PRODUCT-CERTIFICATION OP STEMPELS | SELOS DA CERTIFICAÇÃO DO PRODUTO | 제품 인증 라벨 |
| M | NUMBER OF CELLS | ANZAHL VON ZELLEN | NUMERO DI CELLE | NOMBRE DE CELLULES | NUMERO DE CELULAS | AANTAL CELLEN | NÚMERO DE CELAS | 세포의 수 |
| | | | <p>Storage temperature: from -20°C to +50°C; Lagertemperatur: von -20°C bis +50°C; Temperatura di immagazzinamento: da -20°C a +50°C; Température de stockage: de -20°C à +50°C; Temperatura de almacenamiento: de -20°C a +50°C; Opslagtemperatuur: van -20°C tot +50°C; Temperatura de armazenamento: de -20°C a +50°C; 보관 온도: -20°C a +50°C;</p> | | | | | |
| <p>Relative humidity: 0 – 80% up to 50°C; Relative Feuchtigkeit: 0 – 80% bis 50°C; Umidità relativa: 0 – 80% fino a 50°C; Humidité relative: 0 – 80% jusqu'à 50°C; Humedad relativa: 0 – 80% hasta 50°C; Relatieve luchtvochtigheid: 0 – 80% tot max. 50°C; Humidade relativa: 0 – 80% a 50°C; 상대 습도: 최대 50°C 에서 0 – 80%;</p> | | | | <p>Operating temperature: from 0°C to 40°C; Betriebstemperatur: von 0°C bis 40°C; Temperatura operativa: da 0°C a 40°C; Température d'exploitation: de 0°C à 40°C; Temperatura operativa: de 0°C a 40°C; Bedrijfstemperatuur: van 0°C tot 40°C; Temperatura operativa: de 0°C a 40°C; 작동 온도: 0°C ~ 40°C</p> | | | | |

Important safety instruction. Keep these instructions. This manual contains important instructions for the safety of the user and operation of the device.

GENERAL WARNINGS

- 1) Before each use of the battery charger the instructions set out below must be carefully read and abided by.
- 2) The failure to follow these instructions and /or errors in installing or using the battery charger, could lead to endangering the operator and /or damaging the device, voiding the manufacturer's guarantee.
- 3) The battery charger cannot be used as a component in systems which provide life support and/or medical devices, without explicit written authorisation from S.P.E. ELETTRONICA INDUSTRIALE.
- 4) The battery charger must not be used by persons with reduced physical, sensory and mental capabilities or with lack of experience and/or knowledge, unless they are properly supervised and instructed by a person responsible for their safety.

CHILDREN

- 5) The battery charger must not be used by children. The battery charger is not a toy and must not be treated as such.

WHERE TO INSTALL

- 6) Never place the battery charger in the immediate vicinity of the battery in order to prevent gases produced and/or emitted by the actual battery during charging corroding and/or damaging the battery charger. Place the battery charger as far away from the battery as the length of cables permits.
- 7) Do not install the battery charger in a closed space or in such a way as to somehow prevent ventilation. For units equipped with fans, at least 30 mm clearance must be left around the vents. In order to facilitate the heat exchange of the battery charger it must be positioned vertically, exploiting the fixture holes (where provided).
- 8) Do not use the battery charger outdoors.
- 9) Do not expose the battery charger to rain, water splashes or steam.
- 10) Do not install the battery charger in caravans and / or similar vehicles.
- 11) Do not install the battery charger near any heat sources or in areas with high concentrations of dust.
- 12) Do not install the battery charger near any potential sources of flammable material, for example methane gas pipes or fuel depots (petrol, kerosene, ...).
- 13) Do not place and/or fit the battery charger onto surfaces manufactured out of combustible materials, like wooden shelves or walls.

BATTERIES

- 14) Follow the specific safety instructions provided by the battery manufacturer carefully, for example, whether or not to remove cell caps during charging and the recommended charge rates.
- 15) Working in the vicinity of a lead-acid battery is dangerous, as batteries generate explosives gases during charging. Therefore smoking and/or generating open flames and/or sparks must be avoided.
- 16) Never charge a frozen battery.
- 17) Batteries must be charged in specific, well-ventilated areas.
- 18) In order to reduce risk of injury only charge Lead-Acid, GEL or AGM type, Lithium Polymer or Lithium Ion batteries. Do not charge other types of rechargeable or non-rechargeable batteries as they could explode causing damage and/or injury.

FURTHER SPECIFICATIONS FOR LITHIUM BATTERIES

- 19) In order to charge Lithium Polymer and Lithium Ion batteries, a BMS (Battery Management System) must always be used, comprising an active and passive safety system, in compliance with safety regulations in force.
- 20) The possibility of the BMS acting directly on the battery charger operation during cell balancing phases rules out, for any reason whatsoever, that the battery charger is held directly responsible should damage caused to the battery, or even a fire or an explosion, be due to an error in the BMS software.
- 21) The faculty offered by the materials produced by S.P.E. ELETTRONICA INDUSTRIALE to select different levels of voltage for charging, is entrusted to the control and supervision of the end user and S.P.E. ELETTRONICA INDUSTRIALE is not liable for any consequences resulting from the selection of the incorrect level of voltage. If in doubt, the user should ask a qualified professional for clarification.
- 22) The battery charger tolerance thresholds, as far as levels of over-voltage and overcharging are concerned, are used only for the safeguarding of the systems of the same and have no safety functions for the battery itself, the safety of which depends solely on the BMS, even when the battery charger is connected to the battery, whether the latter is being charged or not.
- 23) Should the client want to use the battery charger on a specific on-board system and in general in any cases of special usage, it is the client's responsibility to inform S.P.E. ELETTRONICA INDUSTRIALE, so that the latter can draw up any necessary recommendations. In this case, the client must provide S.P.E. ELETTRONICA INDUSTRIALE with all designs, diagrams and descriptive material necessary. S.P.E. ELETTRONICA INDUSTRIALE cannot be held

responsible for any damage resulting from the use of the battery charger after opening it and/or modifying it and/or inserting it into other systems.

24) Under no circumstances can S.P.E. ELETTRONICA INDUSTRIALE be held responsible for the malfunctioning of the batteries or the incineration/explosion of these, in so much as the safety of the battery is the task of the BMS and not of the battery charger.

CHECKING CABLES, GRID, EARTHING

25) Do not transport the battery charger by pulling on the cables as they could be damaged. Use the handles, if provided.

26) Before using the battery charger, check that the sleeving on the mains cable and battery cables is in good condition. Should one of the cables be damaged, have it replaced by a S.P.E. ELETTRONICA INDUSTRIALE qualified technician.

27) Check that the input voltage of the battery charger given on the data plate is in line with the voltage available.

28) Check the compatibility of the mains plug supplied with the battery charger: the use of adaptors is not recommended (in Canada it is against the law).

29) The battery charger must be plugged into a socket fitted with an earth wire. Should the socket not be equipped with an earth connection, do not use the device before having a suitable socket installed by a qualified technician.

30) The power socket to which the battery charger is to be connected must be protected by an electrical device by law (fuse and/or automatic cut-out), capable of absorbing an electrical current equalling the absorption of current stated on the matriculation number of the battery charger, increased by 10%.

31) Do not open the battery charger as there are no parts which can be serviced and/or replaced by the user. Only specialised personnel, authorised by S.P.E. ELETTRONICA INDUSTRIALE may carry out servicing which involves opening the actual device. Electrical/electronic components inside may cause electric shocks even if the device is not plugged in.

CHECKING BATTERY CHARGER OPERATION and CURVE

32) Before charging, make sure that the battery charger is in line with the voltage of the battery, that the charging current suits the capacity of the battery and that the selected charging curve (for lead-acid batteries, or for airtight GEL or AGM type batteries, Lithium Polymer or Lithium Ion batteries) is correct for the type of battery to be charged.

33) We recommend fitting a fuse between battery charger and battery. The fuse must be installed along the connection to the positive terminal of the battery. The rating of the fuse must be proportionate to the nominal output current of the battery charger, the diameter of cable used and the environment in which it is to be installed.

34) We recommend unplugging it from the mains supply before connecting and disconnecting batteries.

35) During normal operation of the battery charger, the external surface may become hot and may remain so for a certain period of time after it has been switched off.

36) The battery charger needs no special maintenance, only regular cleaning procedures, to be carried out according to the type of working environment. Cleaning procedures should only be carried out on the external surface of the battery charger. Before starting any cleaning procedures, the mains supply cable and battery cables must be unplugged. Do NOT use water and/or detergents in general and/or pressure washers of any kind when carrying out cleaning.

LACK OF USE

37) If safe operation of the battery charger can no longer be ensured, stop the device and ensure that it cannot be put back into operation.

38) The specifications set out in this manual are subject to change without any notice. This publication replaces any previously supplied information.

GREEN 2 / GREEN 4 High Frequency Battery Charger

USE AND OPERATION

In order to use the battery charger, safety norms contained in laws and regulations and provisions issued by local authorities must be complied with.

User obligations: as per these operating instructions, the *user* is any natural or legal person who directly uses S.P.E. ELETTRONICA INDUSTRIALE charging devices or whomsoever uses them on behalf of the aforementioned person. Under special circumstances, for example, leasing, rental, the *user* is the person who, as per the agreements stipulated between the owner and the user of the S.P.E. ELETTRONICA INDUSTRIALE charging devices, assumes the following obligations.

The *user* shall be responsible for the installation site of the device. He shall check whether particularly sensitive equipment is disturbed by the influence of the battery charger. The installation site shall be chosen so that usage (a high direct current produces magnetic interference) does not affect the operation of electromagnetic devices and magnetic data carriers (for example pace makers, monitors, magnetic disks and diskettes, magnetic tapes, watches etc.).

The *user* shall ensure that the use of S.P.E. ELETTRONICA INDUSTRIALE charging devices complies with regulations in force and that any action which could endanger the life and health of the user or of third parties is prevented, as well as the prevention of damage to property.

The *user* shall ensure that users and operators have read and understood these instructions and that they comply with accident-prevention rules, technical safety rules, and use and maintenance directives

INSTALLATION AND SAFETY WARNINGS

Before connecting the battery charger to the mains and to the battery, **read the following instructions carefully.**

- **In order for the Battery Charger to operate correctly and perform at its best it must be installed on a wall the right way and fixed with rawplugs using the loops provided; ensure the ventilation slits are not obstructed.**
- Only specialised, authorised personnel shall be allowed to carry out work requiring the battery charger to be opened.
- Before starting-up the battery charger check insulation on the mains cable and battery connection connectors.
- Only skilled personnel should intervene on electrical equipment.
- Disconnect from mains before connecting or disconnecting the battery.
- The rating label must be visible after installation.
- CHILDREN: The battery charger must not be used by children. The battery charger is not a toy and not be treated as such. Children being supervised not to play with the appliance.
- The appliance is not to be used by persons with reduced physical, sensor or mental capabilities, or lack of experience and knowledge, unless they have been given supervision or instruction.
- **WARNING !!** Charging batteries produce explosive gas, it is therefore strictly forbidden to smoke in the vicinity; naked flames and/or sparks and proximity to other equipment which could endanger people or property are to be prevented.
- This battery charger contains electrical components which can produce voltaic arcs and sparks, therefore if it is used in confined spaces, it must be installed in a suitable location; in any case the standard battery charger (IP 20) must be used indoors, in well-ventilated spaces, which are not exposed to rain and/or water splashes and be positioned on solid, level flooring, in particular dusty areas or areas where water, heat and humidity originate are to be avoided. Furthermore, the battery charger must not be positioned on support structures and/or shelves made of wood or other flammable material, materials must not be stocked in the vicinity of the battery charger and no kind of object or container for liquids must be placed on the cover. Batteries must be charged in specific, well-ventilated areas.
- In order to reduce the risk of injury only charge Lead - Acid, GEL, AGM types, Lithium Polymer or Lithium Ion batteries. Do not charge other types of rechargeable or non - rechargeable batteries as they could explode causing damage and / or injury.
- In order to prevent risk of electrocution, the battery charger **must be connected to an earthed socket**, furthermore the socket which the battery charger is connected to must be proportionate in power to the charger and be protected by an appropriate compliant electrical device (fuse or automatic cut-out switch). In order to obtain sufficient selectivity, the protection must have a calibration at least 10% higher than the power absorption of the device, furthermore the device must be protected from excessive high contact voltage in compliance with Local Authority provisions.
- We recommend using appropriate bipolar connectors.
- The use of extension leads to lengthen existing electrical connections must be avoided at all costs.
- Do not use additional cables to extend the existing electrical connections. Before using the battery charger,

check that the sleeving on the mains cable and battery cables is in good condition. Should one of the cables be damaged, have it replaced by a S.P.E. ELETTRONICA INDUSTRIALE qualified technician.

- The S.P.E. ELETTRONICA INDUSTRIALE charging device needs no special maintenance, apart from regular cleaning procedures, to be carried out periodically according to the type of working environment. Before starting to clean the device, the mains supply cable and battery cables must be unplugged.
- Where to install:

SUGGESTED MOUNTING HEIGHT: WALL MOUNT – at least 1,5m from the bottom side of the charger, 0,5m from the side wall and at least 0,65m from the top. This to avoid dust and moisture sucked up from the ground level.

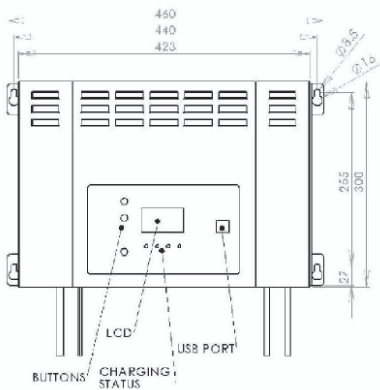

GREEN2

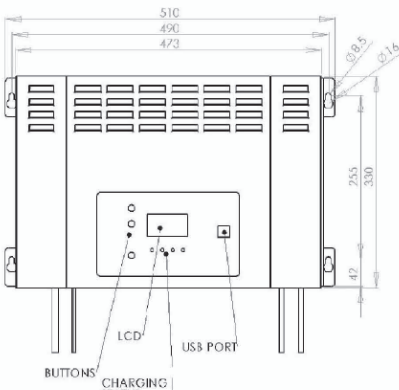

GREEN4

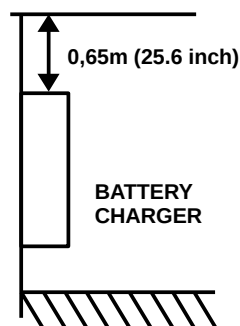
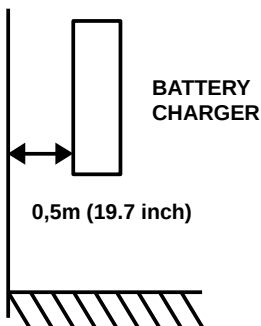
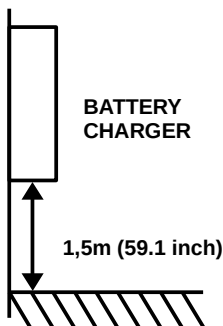

MAINS CONNECTION

The installed battery charger must be connected to a socket proportionate in power to the charger, check the data given on the serial number label:

| MODEL GREEN2 SERIES | | ACTIVE POWER | ABSORBED CURRENT (230Vac) | FUSE AC | MAINS CABLE |
|---------------------|-----|--------------|---------------------------|---------|-------------|
| (V) | (A) | (W) | (A) | (A) | (mmq) |
| 12 | 50 | 857 | 3,7 | GG12 | 3x1,5 |
| 12 | 60 | 1029 | 4,5 | GG12 | 3x1,5 |
| 12 | 70 | 1200 | 5,2 | GG12 | 3x1,5 |
| 24 | 50 | 1714 | 7,4 | GG12 | 3x1,5 |
| 24 | 60 | 2057 | 8,9 | GG12 | 3x1,5 |
| 24 | 70 | 2400 | 10,4 | GG12 | 3x2,5 |
| 36 | 30 | 1543 | 6,7 | GG12 | 3x1,5 |
| 36 | 40 | 2057 | 8,9 | GG12 | 3x1,5 |
| 36 | 45 | 2314 | 10,0 | GG12 | 3x2,5 |
| 48 | 25 | 1714 | 7,4 | GG12 | 3x1,5 |
| 48 | 30 | 2057 | 8,9 | GG12 | 3x1,5 |
| 48 | 35 | 2400 | 10,4 | GG12 | 3x2,5 |
| 72 | 15 | 1543 | 6,7 | GG12 | 3x1,5 |
| 72 | 20 | 2057 | 8,9 | GG12 | 3x1,5 |
| 72 | 25 | 2571 | 11,2 | GG12 | 3x2,5 |
| 80 | 10 | 1143 | 5,0 | GG12 | 3x1,5 |
| 80 | 15 | 1714 | 7,4 | GG12 | 3x1,5 |
| 80 | 20 | 2286 | 9,9 | GG12 | 3x2,5 |

| MODEL GREEN4 SERIES | | ACTIVE POWER | ABSORBED CURRENT (230Vac) | FUSE AC | MAINS CABLE |
|---------------------|-----|--------------|---------------------------|---------|-------------|
| (V) | (A) | (W) | (A) | (A) | (mmq) |
| 24 | 80 | 2743 | 11,9 | GG25 | 3x2,5 |
| 24 | 90 | 3086 | 13,4 | GG25 | 3x2,5 |
| 24 | 100 | 3429 | 14,9 | GG25 | 3x4,0 |
| 24 | 120 | 4114 | 17,9 | GG25 | 3x4,0 |
| 36 | 50 | 2571 | 11,2 | GG25 | 3x2,5 |
| 36 | 60 | 3086 | 13,4 | GG25 | 3x2,5 |
| 36 | 70 | 3600 | 15,6 | GG25 | 3x4,0 |
| 36 | 80 | 4114 | 17,9 | GG25 | 3x4,0 |
| 48 | 50 | 3429 | 14,9 | GG25 | 3x4,0 |
| 48 | 60 | 4114 | 17,9 | GG25 | 3x4,0 |

| | | | | | |
|----|----|------|------|------|-------|
| 48 | 75 | 5143 | 22,3 | GG25 | 3x6,0 |
| 72 | 40 | 4114 | 17,9 | GG25 | 3x4,0 |
| 72 | 50 | 5143 | 22,3 | GG25 | 3x6,0 |
| 80 | 30 | 3429 | 14,9 | GG25 | 3x4,0 |
| 80 | 40 | 4571 | 19,8 | GG25 | 3x6,0 |

BATTERY CONNECTION

We recommend using appropriate compliant bipolar connectors which do not allow polarity reversal of the battery; ensure that the cables are correctly connected to the contacts of the connectors too.

Only specialised personnel should carry out this procedure.

VISUAL SIGNALS

This paragraph describes the displays of the 4 status LEDs during the different operational phases of the battery charger.

| REF | DESCRIPTION | DL4 LED (green) | DL3 LED (yellow) | DL2 LED (green) | DL1 LED (red) | DISPLAY |
|------------|---|--------------------|---------------------|--------------------|------------------|---------|
| S1 | Only battery power supply | OFF | OFF | OFF | OFF | OFF |
| S2 | Only mains power supply | OFF | OFF | OFF | OFF | ON |
| S3 | Both mains and battery power supply | ON | OFF | OFF | OFF | ON |
| S4 | Perform Autostart | BL | BL | BL | BL | ON |
| F1 | Phase 1 – Initial charge CI | BL | OFF | OFF | OFF | ON |
| F2-F7 | Phase 2 – Phase 7 | BL | ON | OFF | OFF | ON |
| F8 | Equalisation period | ON | ON | ON | OFF | ON |
| EQU ON | Equalisation charge ON (in progress) | BL | BL | ON | OFF | ON |
| | | | | | OFF | ON |
| EQU OFF | Equalisation charge OFF (paused) | ON | ON | ON | OFF | ON |
| M | Maintenance | BL | BL | ON | OFF | ON |
| END | Charge Finished | ON | ON | ON | OFF | ON |

Where:

OFF = the led is off

ON = the led is constant

BL = the led is blinking (Blink, T=1 second)

-- = the led can be in any condition

LCD DISPLAY

During charging, the battery charger offers 3 monitor menus, which you can move between by pressing the P2 button, and whose detailed meaning was previously illustrated

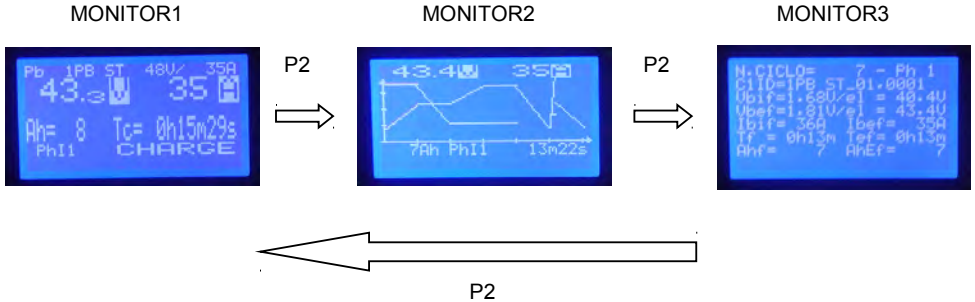

Below is a summary of the information given respectively on the 3 MONITOR displays.

MONITOR 1

| LINE | EXAMPLE | DESCRIPTION |
|------|----------------------|---|
| (1) | Pb 1Pb ST 48V / 35A | Battery Technology, Type of Curve, Battery Charger Rating |
| (2) | 43,3 V 35A | Battery voltage and current |
| (3) | Ah= 8 Tc= 0h 15m 29s | Ah charged, Charging Time in hours, min, sec |
| (4) | Ph11 CHARGE | Current charging phase, battery charger STATUS |
| (5) | -- Messages | (e.g. phase = auto start A0, Status= BATTERY NOT CONNECTED) |

MONITOR 2

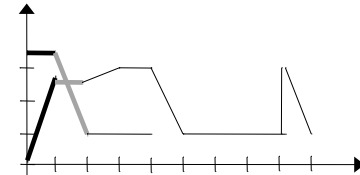
| LINE | EXAMPLE | DESCRIPTION |
|------|---|---|
| (1) | 43,3V 35A | Battery Voltage and Current Supplied |
| (2) |  | Active charge profile with indication: <ul style="list-style-type: none"> • Phases complete (thick line) • Phase in progress (flashing line) • Phases to execute (thin line) |
| (3) | 7Ah Ph11 13m22s | Ah charged, Charging time in hours, min, sec |
| (4) | -- Message | Possible fault or status messages |

MONITOR 3

| LINE | EXAMPLE | DESCRIPTION |
|------|-----------------------|--|
| (1) | N.CYCLE= 7 – Ph 1 | Number of charge cycle and current charge phase E.g. : charge cycle 5 and Phase 3 |
| (2) | C1ID=1PB ST_01.0001 | Charging curve unique identification |
| (3) | Vbif=1.68V/el = 40.4V | Battery voltage at start of phase (Vbif) expressed first as element voltage (V/el), then as absolute voltage (V) |
| (4) | Vbef=1.81V/el = 43.4V | Battery voltage at end of phase (current) (Vbef) expressed first as element voltage (V/el), then as absolute voltage (V) |
| (5) | Ibif= 36A Ibef= 35A | Current at start of phase (Ibif) and current at end of phase (Ibef) |
| (6) | Tf =0h13m Tef=0h13m | Single phase time (Tf) and Overall charge time at end of phase (Tef) |
| (7) | Ahf= 7 AhEf= 7 | Ah supplied in the selected phase (Ahf) and overall charge Ah (AhEf) |
| (8) | -- Message | Indicates any faults occurring during the charge cycle |

GUARANTEE

- The machine is guaranteed 12 months from the date of installation.
- The guarantee covers parts found to be defective in manufacturing or assembly.
- The guarantee does NOT cover damage caused by incorrect usage and/or installation.
- The guarantee lapses if any tampering is discovered.
- For any problems, please refer to an AUTHORISED RETAILER or directly to S.P.E. Elettronica Industriale



CE DECLARATION OF CONFORMITY

According to: UNI CEI EN ISO/IEC 17050-1:2010

We

S.P.E. ELETTRONICA INDUSTRIALE DI POLETTI SERGIO
Via di Mezzo Ponente, 383 – 40014 Crevalcore (Bologna) ITALY

Declare under our sole responsibility that the product:

ELECTRONIC AUTOMATIC BATTERY CHARGER MODEL:

GREEN2 12V 50A, GREEN2 12V 60A, GREEN2 12V 70A, GREEN2 24V 50A, GREEN2 24V 60A, GREEN2 24V 70A, GREEN4 24V 80A, GREEN4 24V 90A, GREEN2 24V 100A, GREEN4 24V 120A, GREEN 2 36V 30A, GREEN2 36V 40A, GREEN2 36V 45A, GREEN4 36V 50A, GREEN4 36V 60A, GREEN4 36V 70A, GREEN4 36V 80A, GREEN2 48V 25A, GREEN2 48V 30A, GREEN2 48V 35A, GREEN4 48V 50A, GREEN4 48V 60A, GREEN4 48V 75A, GREEN2 72V 15A, GREEN2 72V 20A, GREEN2 72V 25A, GREEN4 72V 40A, GREEN4 72V 50A, GREEN2 80V 10A, GREEN2 80V 15A, GREEN2 80V 20A, GREEN4 80V 30A, GREEN4 80V 40A

to which this declaration applies, complies with the provisions of the Directives of the Council of the European Union on the approximation of the laws of the members states:

Relating electromagnetic compatibility (EMC) directive 2014/30/EC of the European Parliament and of the Council of 26 February 2014 on the approximation of the laws of member states relating to electromagnetic compatibility and repealing directive 89/336/EEC, conformity is proven by compliance with the following standards:

- ✓ EN 55014-1:2008+A1:2010+A:2012 (Emission)
- ✓ EN 55014-2:1998+A1:2002+A2:2007+A3:2009 (Immunity – Category II)
- ✓ EN 61000-3-2:2015 (Harmonic Current Emission)
- ✓ EN 61000-3-3:2014+A1:2014 (Voltage Fluctuation and Flicker)

Relating extra low voltage (LVD) directive 2014/35/EC of the European Parliament and of the Council of 26 February 2014 on the harmonisation of the laws of member states relating to electrical equipment designed for use within certain voltage limits, conformity is proven by compliance with the following standards:

- ✓ EN 60335-1:2013+A11:2015
"Safety of household and similar electrical appliance - Part 1: General requirements".
- ✓ EN 60335-2-29:2006+A2:2011
"Safety of household and similar electrical appliance - Part 2: Particular requirements for battery chargers".
- ✓ EN 62233:2009
"Measurement methods for electromagnetic fields of household appliances and similar apparatus with regard to human exposure".

Crevalcore 11-12-2015

Sergio Poletti
President

S.P.E. ELETTRONICA INDUSTRIALE
di Poletti Sergio
Via di Mezzo Ponente n. 383/B
40014 CREVALCORE (BOLOGNA)
Partita IVA n. 02575560369
Codice Fiscale n. 02575560369